

PM 502



en | User manual

Table of contents

1	Safety	4
2	Quick overview	7
2.1	Shipping contents and warranty	7
3	System overview	8
4	Installation	9
5	Connection	10
5.1	Mains input	10
5.2	Audio inputs	10
5.2.1	Mono inputs (MIC/LINE)	10
5.2.2	Stereo inputs	11
5.3	Audio outputs	12
5.3.1	Speaker connection	12
5.3.2	Line level/USB	14
5.3.3	Headphone	15
5.4	Other connections	15
5.4.1	USB data storage	15
5.4.2	FX switch	15
6	Configuration	16
6.1	Phantom power	16
6.2	100 V Direct Drive	16
6.3	Amplifier routing	16
6.4	Speaker processing (LPN)	17
6.5	AUX mode	17
6.6	Locking	18
6.7	Microphone processing (TALK OVER)	19
7	Operation	20
7.1	Mono input	20
7.2	Stereo input	22
7.3	FX	23
7.4	AUX	24
7.5	MASTER	24
7.6	Microphone processing	24
7.7	Equalizer	25
7.8	Display	26
7.8.1	Menu	26
7.9	Indicators	30
7.10	Headphone volume	31
8	Maintenance	32
9	Technical data	33
9.1	Dimensions	37
9.2	Circuit diagram	38
10	Appendices	39
10.1	System examples	39
10.2	Pin assignments	43

1 Safety

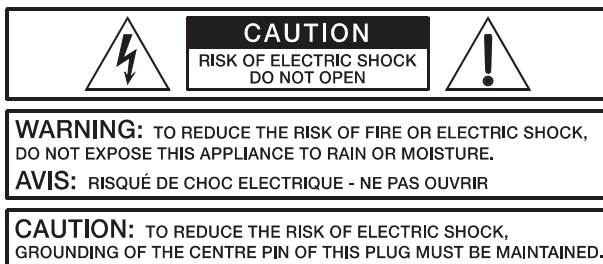

Danger!

The lightning symbol inside a triangle notifies the user of high-voltage, uninsulated lines and contacts inside the devices that could result in fatal electrocution if touched.



Warning!

An exclamation mark inside a triangle refers the user to important operating and service instructions in the documentation for the equipment.

1. Read these safety notes.
2. Keep these safety notes in a safe place.
3. Heed all warnings.
4. Observe all instructions.
5. Do not operate the device in close proximity to water.
6. Use only a dry cloth to clean the unit.
7. Do not cover any ventilation slots. Always refer to the manufacturer's instructions when installing the device.
8. Do not install the device close to heaters, ovens, or other heat sources.
9. Note: The device must only be operated via the mains power supply with a safety ground connector. Do not disable the safety ground connection function of the supplied power cable. If the plug of the supplied cable does not fit your mains socket, please contact your electrician.
10. Ensure that it is not possible to stand on the mains cable. Take precautions to ensure the mains cable cannot become crushed, particularly near the device connector and mains plug.
11. Only use accessories/extensions for the device that have been approved by the manufacturer.
12. Unplug the device if there is risk of lightning strike or in the event of long periods of inactivity. However, this does not apply if the device is to be used as part of an evacuation system!
13. Have all service work and repairs performed by a trained customer service technician only. Service work must be carried out immediately following any damage such as damage to the mains cable or plug, if fluid or any object enters the device, if the device has been used in rain or become wet, or if the device has been dropped or no longer works correctly.
14. Please ensure that no dripping water or spray can penetrate the inside of the device. Do not place any objects filled with fluids, such as vases or drinking vessels, on top of the device.

15. To ensure the device is completely free of voltage, unplug the device from the power supply.
16. When installing the device, ensure that the plug is freely accessible.
17. Do not place any sources of open flame, such as lit candles, on top of the device.
18. This PROTECTION CLASS I device must be connected to a MAINS socket with a safety ground connection.

**Caution!**

Use only manufacturer-approved carts, stands, brackets, or tables that you acquired together with the device. When using carts to move the device, make sure the transported equipment and the cart itself cannot tip over or cause injury or material damage.

IMPORTANT SERVICE INFORMATION**Caution!**

This service information is for use by qualified service personnel only. To avoid the risk of electric shock, do not perform any maintenance work that is not described in the operating instructions unless you are qualified to do so. Have all service work and repairs performed by a trained customer service technician.

1. Repair work on the device must comply with the safety standards specified in EN 60065 (VDE 0860).
2. A mains isolating transformer must be used during any work for which the opened device is connected to and operated with mains voltage.
3. The device must be free of any voltage before performing any alterations with upgrade sets, switching the mains voltage, or performing any other modifications.
4. The minimum distance between voltage-carrying parts and metal parts that can be touched (such as the metal housing) or between mains poles is 3 mm, and must be observed at all times.
5. The minimum distance between voltage-carrying parts and circuit parts that are not connected to the mains (secondary) is 6 mm, and must be observed at all times.
6. Special components that are marked with the safety symbol in the circuit diagram (note) must only be replaced with original parts.
7. Unauthorized changes to the circuitry are prohibited.
8. The protective measures issued by the relevant trade organizations and applicable at the place of repair must be observed. This includes the properties and configuration of the workplace.
9. Observe the guidelines with respect to handling MOS components.

**Danger!**

SAFETY COMPONENT (MUST BE REPLACED BY ORIGINAL PART)

**Notice!**

Due to line current harmonics, we recommend that you contact your supply authority before connection.

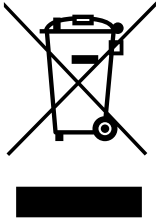
**Old electrical and electronic appliances**

Electrical or electronic devices that are no longer serviceable must be collected separately and sent for environmentally compatible recycling (in accordance with the European Waste Electrical and Electronic Equipment Directive).

To dispose of old electrical or electronic devices, you should use the return and collection systems put in place in the country concerned.

2 Quick overview

Your PM 502 is designed so that you can easily set it up and start using it right away. Follow the steps on the next few pages to set up your PM 502.

**Caution!**

Read all the instructions in this document and the safety notes starting on page 4 before you plug your PM 502 into a power outlet.

2.1 Shipping contents and warranty

Quantity	Component
1	PM 502
1	Power cord
1	User manual
1	Important safety instructions

Warranty

For information regarding the warranty, see www.dynacord.com

3 System overview

Front view

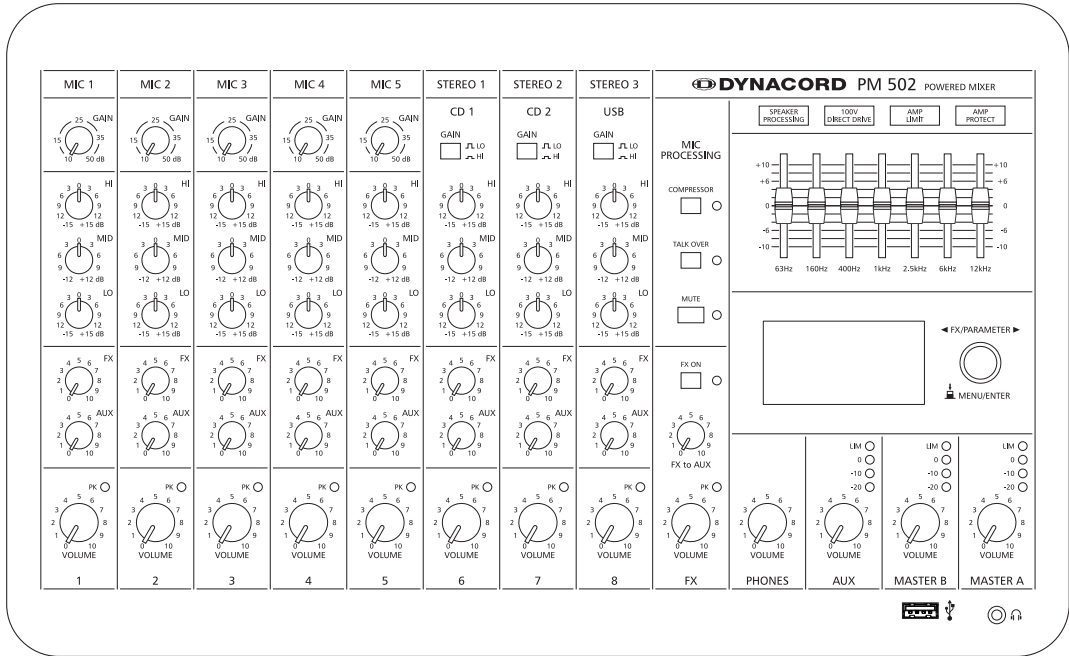

Rear view

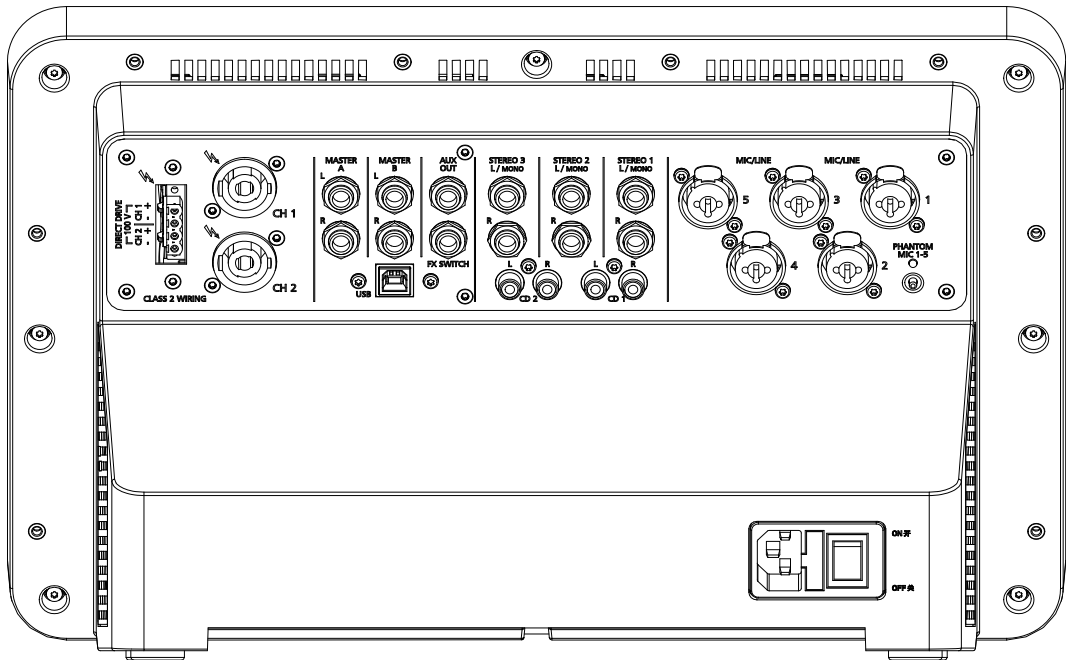

4 Installation

Always place the PM 502 on an even surface to allow for sufficient airflow during the operation. The device is equipped with an electronically controlled fan to protect the power amplifier against thermal overload. The direction of the airflow is right to left. Do not cover the top and side ventilation slots, otherwise, the PM 502 will automatically reduce its output power or it will go into protect mode to prevent thermal overload. If the PM 502 goes into protect mode to help prevent damage to the product, regular operation will be suspended until the product has cooled sufficiently to resume normal operation. Always ensure adequate cooling and appropriate shade to keep the ambient temperature around the product within the specified operating temperature range.



Notice!

Protection foil

Carefully remove the protection foil from the front panel before using the PM 502. Do **not** remove any knobs from the front panel, the foil can be easily removed without having to detach the knobs on the control surface.

Before connecting to the mains supply, please make sure that the device matches the voltage and frequency of your local mains supply. Check the label on the back of the unit.

For a secure connection the speaker outputs CH 1/2 on the back panel of the PM 502 are provided through professional standard high-performance speakON or Euroblock connectors.

Using the RMK 502 Rack mount kit

The RMK 502 Rack mount kit allows the PM 502 to be securely placed into a 19 inch rack, desk or table without covering the ventilation slots. When installing the PM 502 into a rack, please ensure sufficient ventilation. A minimum distance of at least 2 HU above the mixer and 1 HU below the mixer is the minimum space requirement.



Caution!

Use only the supplied screws M4x10. Using longer screws can lead to severe damage of internal parts.

5 Connection

5.1 Mains input



The PM 502 receives its power supply via the IEC mains input. Only the provided power cord may be used. Connect the device only to a mains network that corresponds to the requirements on the back plate.

5.2 Audio inputs



Caution!

Please, make sure to set the input channel VOLUME controls or at least the MASTER or AUX VOLUME controls to their minimum position before connecting an external sound source to any input of the PM 502. This will save you, your audience, and the equipment from unnecessary discomfort.

5.2.1 Mono inputs (MIC/LINE)

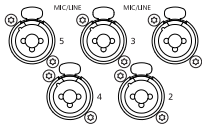

Electronically balanced MIC/LINE inputs 1 to 5 for the connection of a monaural line level signal source or a microphone. Generally, any type of XLR-type microphone can be connected as long as its pin assignment is in accordance to the diagram shown in section *Pin assignments, page 43*.

The connection of balanced or unbalanced signal sources can also be established through monaural or stereo jacks, assigned according to the the illustrations in section *Pin assignments, page 43*. If the device that you want to connect has a balanced output stage, the use of balanced cables with stereo jacks is preferable. This type of connection is less sensitive to the introduction of external noise or HF interference.

Notice!



Please, do not connect E-guitars or E-basses with passive, high impedance outputs directly to a MIC/LINE input. The MIC/LINE inputs of the PM 502, as with the line level inputs of mixers from other manufacturers, are designed for the connection of the relatively low source impedance of electronic instruments. The reproduction of the instrument's original sound characteristics will be unsatisfactory. Connect those instruments using a special transformer or pre-amplifier with very high input impedance. Musical instruments with an active electronic output (battery-powered) can be connected without any problems.

5.2.2

Stereo inputs

Electronically balanced inputs for the connection of musical instruments with stereo output, like keyboards, drum machines, E-guitars and E-basses with an active output as well as all other equivalent sound sources with high level outputs, like additional mixing consoles, FX units, CD players, etc. The stereo LINE input is meant for balanced or unbalanced sound sources with levels between -20 dBu and +26 dBu.

Using jacks

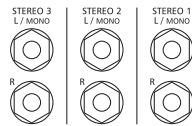

For the connection of external devices to inputs 6, 7 or 8 you can use monaural or stereo jacks, which are in accordance to the diagram in section *Pin assignments, page 43*. If the device that you want to connect has a balanced output stage, the use of balanced cables with stereo jacks is preferable. This type of connection is less sensitive to the introduction of external noise or HF interference. If you want to connect a monaural sound source to a stereo input channel, use the L/MONO input. The signal is routed internally to both channels.

Using RCA plugs



The RCA inputs CD 1 and CD 2 are connected in parallel to the phone inputs STEREO 1 or STEREO 2. It is not recommended to connect signal sources to phone and RCA inputs at the same time.

Using the USB interface

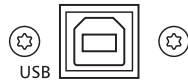

When using the USB interface as an audio input, the stereo signal is routed to STEREO 3. It is not recommended to connect a signal source to the STEREO 3 inputs at the same time.



Notice!

Always check the audio volume setting in your operating system after connecting the PM 502 to your PC. For the best signal-to-noise ratio the volume setting of your PC should be set to maximum level.

5.3 Audio outputs

5.3.1 Speaker connection



Danger!

The arrow symbol next to the speaker output connectors indicates the presence of touch sensitive voltages, which can cause harm to body and health. Please, be sure to adhere to corresponding notes and instructions in this owner's manual when establishing speaker connections.



Caution!

Do not connect low-Z and high-Z speakers simultaneously.



Caution!

The minimum load in Low-Z mode is 4 Ω per channel.

The PM 502 allows connecting

- low impedance (low-Z) speakers (e.g. 4 Ω or 8 Ω) or
- high impedance (high-Z) speakers in Direct Drive mode (see section *100 V Direct Drive*, page 16 for details).

Low-Z speakers can be connected via speakON or Euroblock connectors. High-Z speakers shall be connected via the Euroblock connectors only, please refer to the following sections.

speakON

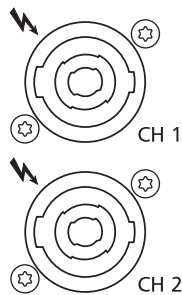

The PM 502 is equipped with professional speakON high-performance connectors, offering electrical and mechanically secure connection, which complies to all security regulations. It also allows the use of high quality speaker cables with diameters of 4 x 2.5 mm². The pin assignment of these sockets is 1+ (hot) and 1- (cold).



Notice!

Using original Neutrik connectors (e.g. NL4FC) is recommended for optimal audio quality.



Notice!

Using passive subwoofers, which sum the input signal of the left and right channel, is not possible for technical reasons.

Euroblock connector in low-Z mode

When the Direct Drive mode is not activated, the Euroblock connector CH 1/2 +/- is in parallel to the speakON connectors CH 1/2 and can be used alternatively.

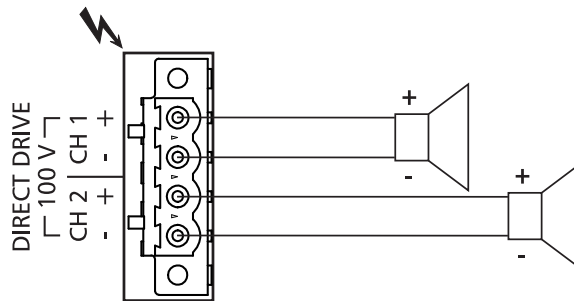

Figure 5.1: Connection of low impedance speakers

Euroblock connector in high-Z mode

When the Direct Drive mode is activated, use pin + of CH 1 and pin - of CH 2 to connect the 100 V loudspeaker line, see following illustration.

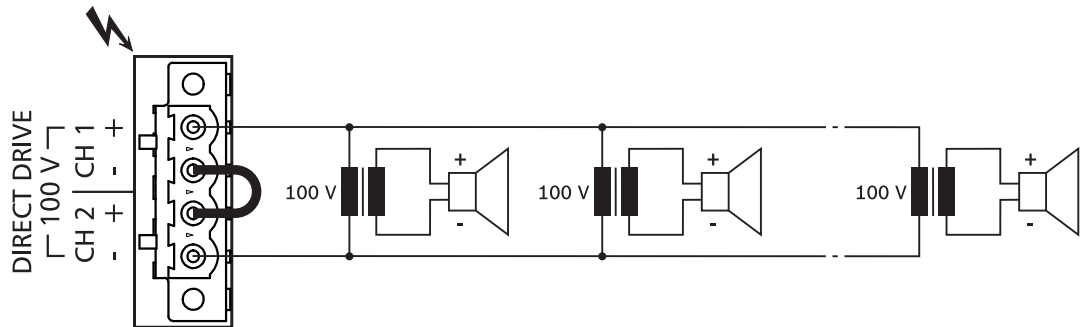

Figure 5.2: Connection of a 100 V speaker line



Notice!

Make sure to bridge pins 1- and 2+ of the Euroblock connector.

5.3.2 Line level/USB



Notice!

All outputs are designed in Ground Sensing technology to prevent the induction of external noise, even with long cables. Use balanced cables for the connection of external components whenever it is possible.

MASTER A L/R

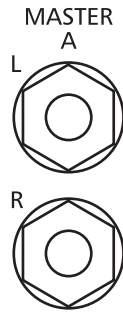

The MASTER A, L/R output signals are post master A volume control and mainly meant to feed additional, external power amplifiers or DSP systems. The output is stereo/mono-switchable, please refer to section *Menu*, page 26.

MASTER B L/R

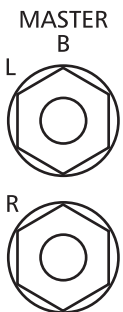

The MASTER B, L/R outputs the L/R master audio signal is present that can be used for additional monitoring, side fill and additional zone applications, or for the connection of a delay-line or subwoofer. The output is stereo/mono switchable and also pre/post switchable. Please refer to section *Menu*, page 26.

AUX OUT



This output provides connection for e.g. a power amplifier or active stage monitor speaker systems. The AUX OUT can also be switched to master signal (pre or post) if a 3rd master out signal is required. Please refer to section *Menu*, page 26.

USB

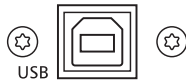

The L/R master audio signal is always present at the USB interface. This allows using your PC/Mac for recording while the PM 502 functions as premium A/D converter, without the need for an external sound card.

5.3.3 Headphone



Stereo phone jack (3.5 mm) for the connection of headphones with an impedance of 32–600 Ω . The phones output presents the master signal. The corresponding control is described in section *Headphone volume*, page 31. The output is protected against short circuit.

Headphones or in ear monitor systems with an impedance below 32 Ω can be connected, in this case the maximum reachable volume is reduced.

5.4 Other connections

5.4.1 USB data storage

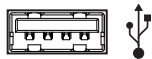

Connect a USB flash drive or external hard drive to the USB port on the front panel to use the integrated audio player of the PM 502. The external memory is scanned automatically for suitable audio tracks (MP3 or WAV). If audio tracks are detected, the audio player dialog will be shown in the LC-Display automatically.



Notice!

Powering external drives through USB

The USB 2.0 port of the PM 502 provides up to 500 mA to USB peripherals. Peripherals exceeding this limit may not work properly, make sure to use an external power adaptor to supply such devices.

5.4.2 FX switch



FX SWITCH

A jack FX SWITCH for the connection of an optionally available FS 11 (DC-FS11) footswitch from Dynacord to switch the effect mode of the internal FX unit on or off. To enable this function, the FX ON switch (see section *FX*, page 23) on the front panel has to be engaged.

6 Configuration

6.1 Phantom power

PHANTOM
MIC 1-5



When condenser microphones are connected, you have to press the PHANTOM MIC 1-5 button. The microphone gets its operating voltage (+48 V DC) through the mixer. Phantom power is activated/deactivated for all 5 MIC/LINE inputs together.

6.2 100 V Direct Drive

The 100 V Direct Drive mode of the PM 502 allows connection of 100 V loudspeaker lines in high impedance mode (High-Z) without using output transformers. In this case the maximum number of loudspeakers connected to an output channel is only limited by the amplifier's output power. This mode should be used if the distance between the amplifier and the speaker is larger than 50 meters (approx. 150 feet) and/or a high number of small speakers with transformers (e.g. ceiling speakers) are used. Depending on the audio signal a 50 Hz or 70 Hz high-pass filter can be selected, the LPN filter is deactivated automatically if the 100 V Direct Drive mode is activated.



Notice!

70 V loudspeaker lines

Next to 100 V loudspeaker lines it is possible to drive 70 V loudspeaker lines. In this case the limiter of the channel selected for Amp Routing (e.g. MASTER A) has to be set to +3 dBu in the OUTPUT SETTINGS LIMITERS dialog.

Please refer to section *Menu, page 26*, how to activate Direct Drive. When activated, the 100V DIRECT DRIVE indicator on the front panel lights green. For connecting 100 V loudspeaker lines to the PM 502 please refer to section *Speaker connection, page 12*.

6.3 Amplifier routing



Caution!

Make sure to set both the AUX and MASTER volume controls to their minimum position before editing the amplifier routing.

The two output channels CH 1/2 of the integrated power amplifier can be used for different audio signals. Please refer to section *Menu, page 26*, how to edit the amplifier routing. Following table lists all amplifier routings available.

Routing	Low-Z mode		High-Z mode (Direct Drive)
	CH 1	CH 2	CH 1 + 2
MASTER A	Master A left	Master A right	Master A summed
MASTER B	Master B left	Master B right	Master B summed
AUX	AUX	AUX	AUX

Routing	Low-Z mode		High-Z mode (Direct Drive)
	CH 1	CH 2	CH 1 + 2
Dual A – B	Master A summed	Master B summed	-
Dual A – AUX	Master A summed	AUX	-
Dual B – AUX	Master B summed	AUX	-

Table 6.1: Amplifier routing

6.4 Speaker processing (LPN)

The power amplifier channels of the PM 502 incorporate Low-Pass-Notch filters (LPN) exclusively designed by DYNACORD. The LPN filter corrects the frequency and phase response of the connected loudspeakers. This effect can not be achieved using equalizers or „Bass-Boosters“, because the LPN filter mainly optimizes the transient response of the connected speaker. The result is a more powerful sound, especially when using small to medium full-range speakers.

Please refer to section *Menu, page 26*, how to edit the LPN filters setting. The following table describes the available LPN filter settings.

Setting	SPEAKER PROCESSING indicator	Description
HIGH	ON	In setting HIGH the LPN filter is activated, this setting is recommended for small to medium sized loudspeakers, e.g. full-range speakers with 12“, 8“ or smaller woofers.
MEDIUM	ON	In setting MEDIUM the LPN filter is activated, this setting is recommended for medium to large loudspeakers, e.g. full-range speakers with 15“ or 18“ woofers.
FLAT	OFF	In setting FLAT the LPN filter is deactivated. Use this setting for large loudspeaker systems with more than one subwoofer.

Table 6.2: LPN filter settings

6.5 AUX mode

The signal that is to be output via AUX OUT can be selected for the particular application. Please refer to section *Menu, page 26*, how to edit the AUX mode. The following table lists all AUX modes available.

Setting	Signal at AUX OUT	Description
AUX-Bus	AUX	This is the default AUX mode, the signal of the AUX bus is present at the AUX OUT output. This mode is mainly used for monitoring. AUX is especially preferable when monitoring and master mix need to be completely different from each other, e.g. when the volume setting of particular musical instruments or vocals needs to be higher or lower than in the master mix.
MAS A Pre	Pre Master A summed	The summed MASTER A signal is present at the AUX OUT output. The signal is tapped pre MASTER A volume control and therefore not affected by the MASTER A control's setting.
MAS A Post	Post Master A summed	The summed MASTER A signal is present at the AUX OUT output. The signal is tapped post MASTER A volume control and therefore affected by the MASTER A control's setting.

Table 6.3: AUX modes

6.6

Locking

The PM 502 allows locking certain features or parameter settings in the menu. A four digit PIN is used to lock or unlock the device. You can use one of three predefined locking levels or select manually which parts of the menu should be locked, please refer to the following table for details.

Menu	Lock Mode			
	Level 1	Level 2	Level 3	Custom
FX selection in home screen	-	-	-	-
EDIT FX	-	-	X	<ol style="list-style-type: none"> Select the Lock Mode "Custom" in the DEVICE SETUP menu. Activate the key icon of all menus to be locked. Enter the PIN in the DEVICE SETUP menu to lock all menus selected in step 2.
AUDIO PLAYER	-	-	-	
MIC PROCESSING	-	-	X	
SPEAKER PROC	-	-	X	
MASTER A EQ	-	X	X	
MASTER B EQ	-	-	X	
AUX EQ	-	-	X	
MASTER ROUTING	-	X	X	
OUTPUT SETTINGS	X	X	X	
DEVICE SETUP 1	-	X	X	

Menu	Lock Mode			
	Level 1	Level 2	Level 3	Custom
DEVICE SETUP 2	-	-	-	
INFORMATION	-	-	-	

Table 6.4: Locking levels (- = available, X = locked)

6.7 Microphone processing (TALK OVER)

The integrated ducker of the PM 502 reduces the level of the signals at the STEREO inputs whenever a signal is present at the MIC/LINE inputs (above the THRESHOLD level). If there is no MIC/LINE signal present the STEREO signal automatically returns to its preset level. Please refer to section *Menu*, page 26 how to edit the TALK OVER settings.

The following diagrams illustrate the available presets. The parameters of the ducker allow adjusting the presets for your application.

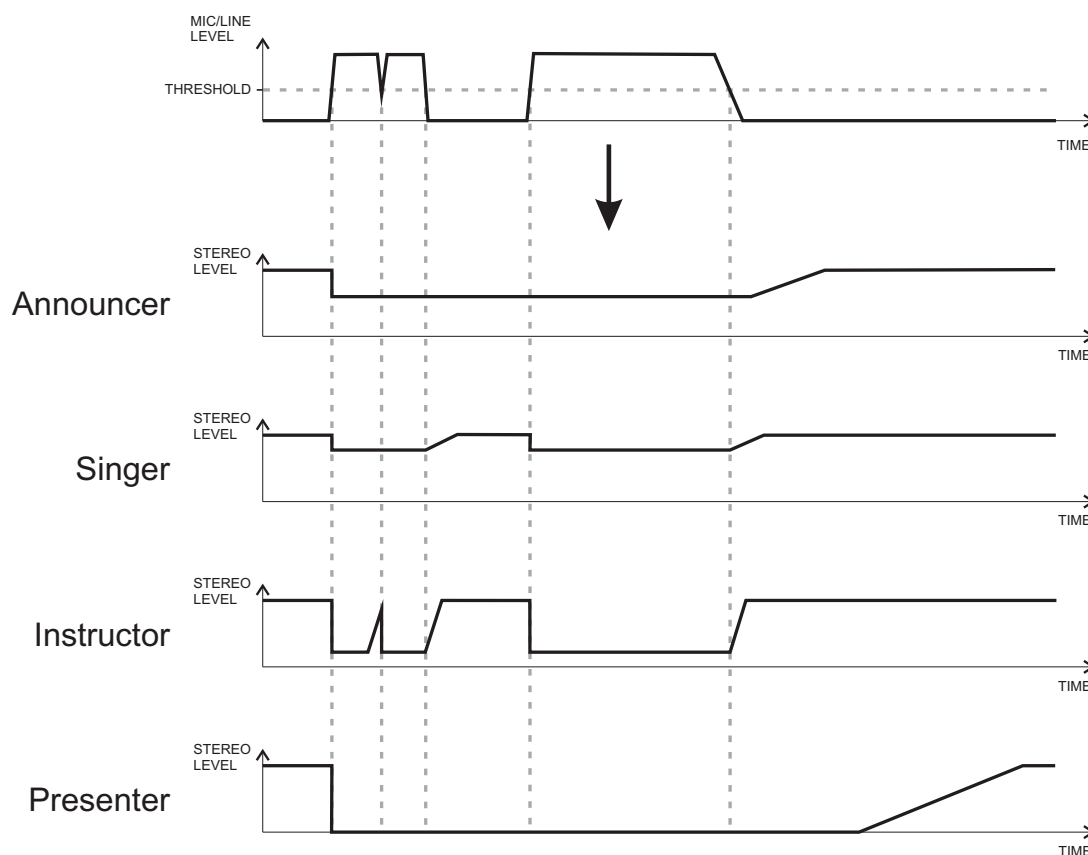
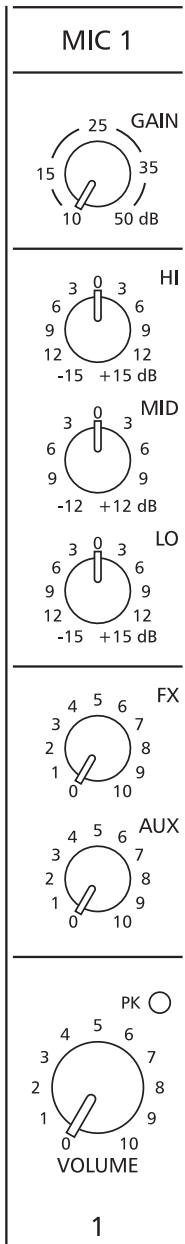

Figure 6.1: TALK OVER presets (the illustration is not to scale)

7 Operation

7.1 Mono input



GAIN control

Rotary control for adjusting a MIC/LINE input's sensitivity. These controls let you optimally adjust the incoming signals to the mixer's internal operation level. Slight adjustments can offer the benefits of an improved S/N-ratio and provides you with the full bandwidth of the PM 502's outstanding sound capabilities. The following gain setting instruction is to be used as a guide to help achieve a good signal input level:

1. Set the MASTER volume controls to their minimum values (counterclockwise).
2. Set the GAIN control and the corresponding channel VOLUME control to their center position.
3. Connect the sound source (microphone, instrument, etc.) to the desired MIC/LINE input.
4. Start the sound source at the highest volume level to be expected – respectively sing or speak as loudly as possible directly (close up) into the microphone.
5. While playing the sound source or singing into the microphone, adjust the input level using the GAIN control, so that during the loudest part, the PK LED does not light up. This is the basic channel setting, leaving you with at least 6 dB of headroom, i.e. you have at least a range of 6 dB before signal clipping occurs.

If you intend to make further adjustments to the channel's EQ setting, you should perform steps 4 and 5 again, as changes in the sound shaping section also have an influence on the channel's overall level.

HI/MID/LO controls

The mixer's EQ section allows for a broad difference in the shaping of the incoming audio signal within three frequency bands. Turning one of the EQ level controls to the right enhances/amplifies the corresponding frequency range while turning it to the left lowers/attenuates the signal of that specific frequency band. Before you begin to alter the sound, all EQ controls should be set to their neutral position, i.e. their marker points straight up (locked in place). Try not to set the EQ controls to extreme positions. Usually, minor changes are sufficient to produce the best results in the overall sound. You should use the natural reproduction as a starting point and rely on your musically trained ear. The moderate use of the MID control is the best remedy to avoid acoustical feedback. You should try to avoid using this frequency range to an extreme level. Lowering the level in this band will provide you with higher output and help reduce feedback. Adjust the LO control to your taste, to add more "punch" to the sound of a kick drum or "body" to the vocals. Use the HI control in the same way to provide cymbals and vocals with more treble for a more transparent sound.

FX control

The FX controls is used to set the amount of effect you require on that channel input to be routed to the integrated FX effects unit. The signal path is split post VOLUME control so that the volume setting also influences the amount of the signal that is fed to the FX unit. Using the FX controls lets you easily assign an effect for groups of musical instruments or vocals. To determine the desired level of the effect, you should start with the controls set at their center and make individual adjustments from there on.

Please monitor the PK LED in the FX channels. The indicator should only light up briefly at the occurrence of high signal peaks. If the indicator is constantly lit, you should lower the send levels of those channels where the program peaks occur. For further information, please read the paragraphs about the FX unit.

AUX control

The AUX control is primarily meant for establishing an independent mix, e.g. for monitor or a second room/zone. The signal routing is always pre VOLUME control.

PK indicator

The peak indicator plays a key role when setting input levels. The PK (peak) LED on the PM 502 provides a visual indication of the risk of distortion before you hear it through the connected speaker systems. The peak indicator checks the signal level pre and post of the channel's VOLUME control and indicates the maximum of both levels. If the PK LED blinks frequently or lights continuously, the corresponding channel is likely to start clipping and you will need to reduce the volume slightly. The peak LED are triggered at a level of -6 dB below the point of distortion.

If lowering the channel VOLUME is not sufficient to reduce signal peaks, carefully turn the GAIN control down.

Keeping an eye on the indicator during a performance is also a good idea, because some changes in the bands dynamics or even a change in keyboard settings can easily lead to channel clipping, resulting in the degradation of the overall sound.

VOLUME control

The VOLUME control sets the volume of the corresponding channels, resulting in a balanced mix. The control should be positioned initially at "5", leaving you with enough flexibility to balance the mix. The overall volume is adjusted through the use of the master controls. Even though the channel controls offer an additional level of +15 dB, we would like to advise you to exceed the "8" mark only in very few exceptional cases. If the PM 502's summing bus gets "overloaded" with too many "high level" input channels, despite its special gain structure, the summing amplifier could be driven into clipping.

The best signal to noise ratio can be achieved if channel volume and master volume controls are set in the same range.

7.2

Stereo input

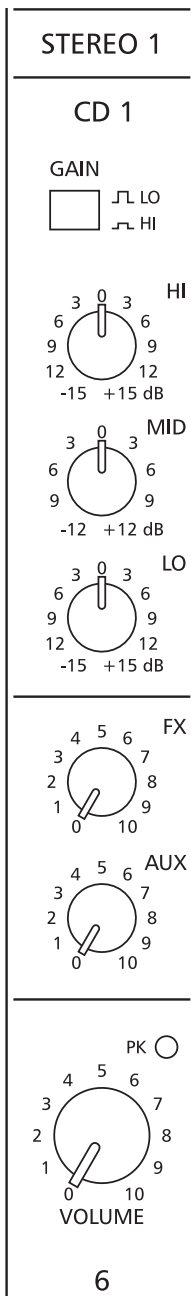

GAIN switch

Use the GAIN switch for switching between high (HI) or low (LO) input signal amplification. The default setting is LO (-5 dB), which is suitable for all high level input sources like keyboards or CD players. HI gain should be engaged when connecting low signal level instruments like bass or guitar.

HI/MID/LO control

The mixer's EQ section allows for a broad difference in the shaping of the incoming audio signal within three frequency bands. Turning one of the EQ level controls to the right enhances/amplifies the corresponding frequency range while turning it to the left lowers/attenuates the signal of that specific frequency band. Before you begin to alter the sound, all EQ controls should be set to their neutral position, i.e. their marker points straight up (locked in place). Try not to set the EQ controls to extreme positions. Usually, minor changes are sufficient to produce the best results in the overall sound. You should use the natural reproduction as a starting point and rely on your musically trained ear. The moderate use of the MID control is the best remedy to avoid acoustical feedback. You should try to avoid using this frequency range to an extreme level. Lowering the level in this band will provide you with higher output and help reduce feedback. Adjust the LO control to your taste, to add more "punch" to the sound of a kick drum or "body" to the vocals. Use the HI control in the same way to provide cymbals and vocals with more treble for a more transparent sound.

FX control

The FX controls is used to set the amount of effect you require on that channel input to be routed to the integrated FX effects unit. The signal path is split post VOLUME control so that the volume setting also influences the amount of the signal that is fed to the FX unit. Using the FX controls lets you easily assign an effect for groups of musical instruments or vocals. To determine the desired level of the effect, you should start with the controls set at their center and make individual adjustments from there on.

Please monitor the PK LED in the FX channels. The indicator should only light up briefly at the occurrence of high signal peaks. If the indicator is constantly lit, you should lower the send levels of those channels where the program peaks occur. For further information, please read the paragraphs about the FX unit.

AUX control

The AUX control is primarily meant for establishing an independent mix, e.g. for monitor or a second room/zone. The signal routing is always pre VOLUME control.

PK indicator

The peak indicator plays a key role when setting input levels. The PK (peak) LED on the PM 502 provides a visual indication of the risk of distortion before you hear it through the connected speaker systems. The peak indicator checks the signal level pre and post of the channel's VOLUME control and indicates the maximum of both levels. If the PK LED blinks frequently or lights continuously, the corresponding channel is likely to start clipping and you will need to reduce the volume slightly. The peak LED are triggered at a level of -6 dB below the point of distortion.

If lowering the channel VOLUME is not sufficient to reduce signal peaks, carefully turn the GAIN control down.

Keeping an eye on the indicator during a performance is also a good idea, because some changes in the bands dynamics or even a change in keyboard settings can easily lead to channel clipping, resulting in the degradation of the overall sound.

VOLUME control

The VOLUME control sets the volume of the corresponding channels, resulting in a balanced mix. The control should be positioned initially at “5”, leaving you with enough flexibility to balance the mix. The overall volume is adjusted through the use of the master controls. Even though the channel controls offer an additional level of +15 dB, we would like to advise you to exceed the “8” mark only in very few exceptional cases. If the PM 502’s summing bus gets “overloaded” with too many “high level” input channels, despite its special gain structure, the summing amplifier could be driven into clipping.

The best signal to noise ratio can be achieved if channel volume and master volume controls are set in the same range.

7.3

FX

FX ON switch (with indicator)

This switch turns the internal FX unit on and the green LED turns on. Please keep in mind that you can also use an external footswitch for turning the FX unit on or off. In this case, the LED also shows the actual operational status of the FX unit. If you want to use a footswitch, the FX ON switch has to be engaged first. The FX unit is activated and you can use the footswitch to switch the selected effect program on or off.

FX to AUX control

This control allows you to add the FX output signal (pre volume control) to the AUX channel.

PK indicator

This indicates to the user that the internal FX unit is on the verge of clipping, e.g. at a level of -6 dB below the risk of overdrive. To achieve an adequate signal to noise ratio, please adjust the FX units’ input level as follows:

1. Establish a “dry” mix – without effect settings – refer to the previous instructions.
 2. Position the FX VOLUME control at the “5” mark.
 3. Turn the FX/PARAMETER rotary control to select the desired FX program preset.
 4. Press the FX ON switch.
 5. Play the sound source connected to the desired input channel and adjust the desired amount of the FX signal, using the FX controls of this input channel. Repeat this step for all input channels that you want to include in your effect mix.
 6. Monitor the PK LED so that it only lights up from time to time during signal peaks. When clipping occurs, reduce the channels FX control level.
 7. Use the FX to AUX control to add the effect mix to the AUX mix.
 8. Use the FX VOLUME control to add the desired amount of the FX signal to the master mix.
- Pay attention to the PK indicators when operating your PM 502 to be able to respond quickly when the signal levels exceed the normal range and start clipping.

VOLUME control

This control is used to determine the amount of effect added to the master mix. If you find that you have to set these controls above the “8” mark, please check if the FX unit’s input signals are adjusted properly.

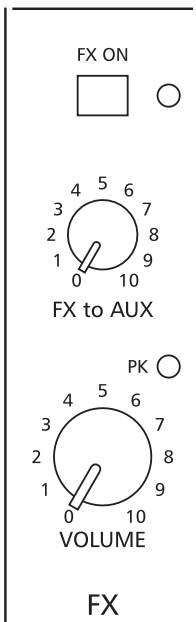

7.4

AUX

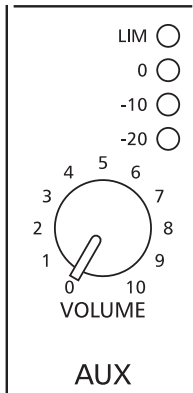

Indicators

It is acceptable for the LIM indicator to flicker from time to time because the built in clip limiter prevents distortion. If it is lit continuously, you are at risk of the degradation of your speaker output. In that case, the volume level has to be reduced. The limiter threshold can be edited in the OUTPUT SETTINGS menu, please refer to section *Menu, page 26*.

Below the LIM indicator, the PM 502 offers a 3-segment LED chain for visual monitoring of the output level of the signal. The meter's 0 dB mark is referenced to a 0 dBu output signal at the mixer output.

VOLUME control

The VOLUME control sets the volume of the summed audio signal at the AUX OUT output. The signal present at this output can be selected in the AUX routing menu, please refer to section *Menu, page 26*.

7.5

MASTER

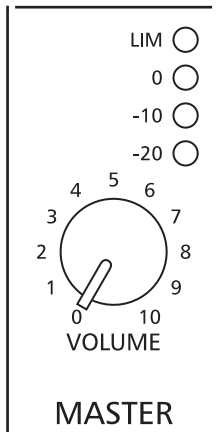

Indicators

It is acceptable for the LIM indicator to flicker from time to time because the built in clip limiter prevents distortion. If it is lit continuously, you are at risk of the degradation of your speaker output. In that case, the volume level has to be reduced. The limiter threshold can be edited in the OUTPUT SETTINGS menu, please refer to section *Menu, page 26*.

Below the LIM indicator, the PM 502 offers a 3-segment LED chain for visual monitoring of the output level of the signal. The meter's 0 dB mark is referenced to a 0 dBu output signal at the mixer output.

VOLUME control

Level controls to adjust the output signals of the left and right master outputs (MASTER A or MASTER B). If post mode is selected for MASTER B (see section *Menu, page 26*) set the MASTER B level control to its middle position for identical levels on MASTER A or B outputs.

7.6

Microphone processing

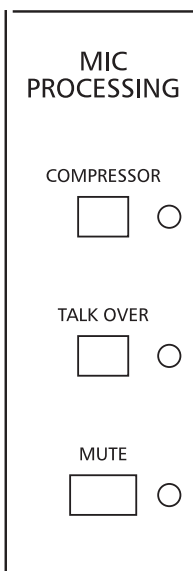

During operation the audio signal processing can be adjusted by using the switches COMPRESSOR, TALK OVER or MUTE, this settings always affect the input signals of all MIC/ LINE channels. The current status is indicated by the corresponding LED next to each button. Advanced microphone processing settings are available in the menu, please refer to section *Menu, page 26*.



Notice!

Effect of MIC PROCESSING

The AUX-Bus signal is only affected by MUTE, so COMPRESSOR or TALK OVER have no effect on the AUX-Bus signal.

COMPRESSOR

Engage the COMPRESSOR switch to activate the integrated compressor. The compressor reduces the dynamic range of audio signals. Once the signal exceeds a certain threshold, the signal gets compressed, i.e. major input level changes result in minor output level changes. Narrowing the dynamic range often allows for easier recording or mixing the audio signal.

TALK OVER

Engage the TALK OVER switch to activate the integrated ducking facility. The ducking facility reduces the level of the signals at the STEREO inputs whenever a signal is present at the MIC/LINE inputs. If there is no MIC/LINE signal present the STEREO signal automatically returns to its preset level.

MUTE

Engage the MUTE switch to mute all MIC/LINE input signals.

7.7

Equalizer

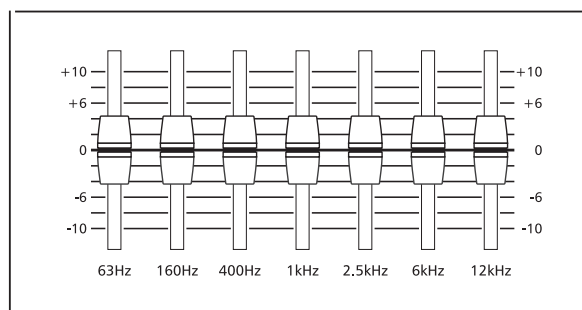

The PM 502 employs a 7-band stereo graphic equalizer (GEQ). Seven frequency bands offering 10 dB gain/reduction and a quality of $Q = 1.5$ allow the shaping of the overall sound to meet your personal preferences or to optimally match it to the acoustic conditions of different locations.

Independent graphic equalizers for MASTER A, MASTER B or AUX (each adjustable via hardware controls or the rotary encoder) are available in the menu, please refer to section *Menu, page 26*.

GEQ setting instructions

The frequency ranges as well as the characteristics of the EQ faders are very practice-oriented. If you want to have a clear and highly intelligible sound, which, as a side effect, provides the cymbals with a more crisp sound, you should raise the levels of the 12 kHz or 6 kHz band a bit. If the mids are nasa you should attenuate the mid range (400 Hz to 2.5 kHz) by a few decibels. To provide the kick drum with more punch you have to boost the low frequency range, using the 63 Hz or the 160 Hz controls. In case the overall sound is undefined with too much bass, lowering the levels of these two frequency bands will solve the problem. However, especially with equalization you should be aware of the fact that in most cases fewer adjustments provide better results. Thus, your first choice should be to establish the mix using only the input channel controls and see if you get a satisfactory result.

7.8 Display

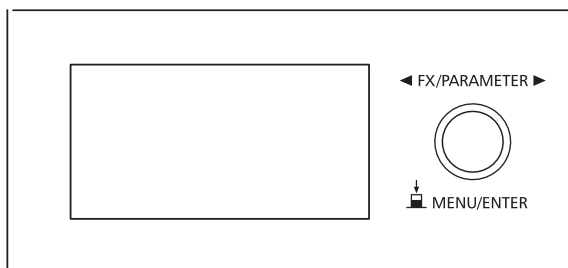

The PM 502 includes a back-lit LC-display.

Home screen

The home screen appears after switching the PM 502 on. After a few seconds the currently selected effect (number and name) is displayed. If effect parameters have been edited, an “E” is indicated next to the preset number. Turn the FX/PARAMETER rotary control to select another effect.

In the lower part of the display settings of the channels **MASTER A**, **MASTER B** and **AUX** are indicated, please refer to following table.

Icon	Description
/MIC	LO CUT in menu MIC PROCESSING is activated.
POST	The master routing of channel B is set to Post.
M	The channel is set to Mono.
DLY	The delay of the channel is activated.
MAS. A PRE or MAX. A POST	Indicates the AUX Mode setting of the AUX channel.
Equalizer control icon	The hardware equalizer controls are used to edit the equalizer settings of this channel.
EQ	The equalizer setting of the channel is not set to flat.
LIM	The threshold of the output limiter has been edited.
Speaker icon	Indicates the Amp Routing. If a Dual Amp Routing is selected speakers for output channel 1 or 2 are indicated.

Table 7.1: Indicators in home screen

If the screensaver is activated the Dynacord logo and the device name (assigned in the DEVICE SETUP menu) is indicated after some time.

7.8.1 Menu

Menu

Press the MENU/ENTER rotary encoder to access the menu.

In menu the MENU/ENTER rotary encoder is used for navigation and for selecting and editing parameters. Turn the MENU/ENTER rotary encoder to the left or to the right to move the cursor in the menu. Press the MENU/ENTER rotary encoder to select the highlighted menu item. The value is shown in inverse font and can be edited by turning the MENU/ENTER rotary encoder. Press the MENU/ENTER rotary encoder again to apply the edited parameter value. Following table lists the content of the menu.

Menu item	Subitems/parameter range (default setting in bold)	Description
EDIT FX	Depends on effect type.	This dialog allows editing effect parameters of the effect unit. Select RESET to reset all parameters to their default values.
AUDIO PLAYER	<ul style="list-style-type: none"> • Folder/Track name • Progress bar • Buttons for Start/Pause/Back/Forward • REPEAT/RANDOM selection • AUTO PLAY selection 	This dialog allows to use the integrated MP3 player. When AUTO PLAY is selected the playback of MP3 files will start automatically when a USB drive is connected.
MIC PROCESSING	<ul style="list-style-type: none"> • LO CUT: Off, 80 Hz, 150 Hz 	When the low cut filter is activated, frequencies below 80 Hz (or 150 Hz) are attenuated.
	<ul style="list-style-type: none"> • COMPRESSOR PRESET: Soft, Hard • COMPRESSOR THRESHOLD: The range depends on the selected compressor preset. • COMPRESSOR TYPE: 2:1 Ratio, 4:1 Ratio, Limiter, Uplift Soft • COMPRESSOR ATTACK: 1–1000 ms • COMPRESSOR RELEASE: 50–10000 ms • COMPRESSOR MAKEUP GAIN: 0 – +6 dB 	The compressor settings allow adjusting the microphone processing to your application.
	<ul style="list-style-type: none"> • TALK OVER PRESET: Announcer, Singer, Instructor, Presenter • TALK OVER THRESHOLD: -50 – -10 dB • TALK OVER DAMPING: -100–0 dB • TALK OVER ATTACK: 0–1000ms • TALKOVER HOLD: 0.0–99.9s • TALK OVER RELEASE: 0.1–30.0s 	The talk over settings allow adjusting the microphone processing to your application. Please refer to section <i>Microphone processing (TALK OVER)</i> , page 19 for more details.

Menu item	Subitems/parameter range (default setting in bold)	Description
SPEAKER PROC	<ul style="list-style-type: none"> Low Pass Notch: Flat, Medium, High 	<p>This menu is used to edit the LPN Speaker Processing filter setting of the integrated power amplifiers. Please refer to section <i>Speaker processing (LPN)</i>, page 17 for more details.</p> <p>If the DIRECT DRIVE mode is activated, the Low Pass Notch filter is always bypassed.</p>
MASTER A EQ	<ul style="list-style-type: none"> SLIDERS-LINK Frequency bands 63 Hz, 160 Hz, 400 Hz, 1 kHz, 2.5 kHz, 6 kHz, 12 kHz 	<p>Activate the entry SLIDERS-LINK to edit the levels of the corresponding GEQ bands using the GEQ hardware controls. If not activated, edit the bands in the display using the FX/PARAMETER rotary control.</p>
MASTER B EQ		
AUX EQ		
MASTER ROUTING	<ul style="list-style-type: none"> MASTER A: Mono, Stereo 	<p>When MASTER A is set to Stereo, the MASTER A L/R signal is not changed and outputted in stereo. When Mono is selected the MASTER A L/R signal is summed and outputted in mono at MASTER A L and also MASTER A R.</p>
	<ul style="list-style-type: none"> MASTER B: Pre, Post; Mono, Stereo 	<p>When MASTER B is set to Pre, the audio signal is tapped pre MASTER A volume control and therefore not affected by the MASTER A control's setting. When MASTER B is set to Post, the audio signal is tapped post MASTER A volume control and therefore affected by the MASTER A control's setting. This mode is mainly used for subwoofers or delay lines.</p> <p>When MASTER B is set to Stereo, the MASTER B L/R signal is not changed and outputted in stereo. When Mono is selected the MASTER B L/R signal is summed and outputted in mono at MASTER B L and also MASTER B R.</p>
	<ul style="list-style-type: none"> MAS. B Delay: : 0.0–50 Meters 	<p>The MASTER B signal can be delayed up to 145.8 ms. The unit can be switched between milliseconds (ms), meters and feet.</p>

Menu item	Subitems/parameter range (default setting in bold)	Description
OUTPUT SETTINGS	<ul style="list-style-type: none"> DIRECT DRIVE: Off, On/50Hz HPF, On/70Hz HPF AMP ROUTING: MASTER A, MASTER B, AUX, Dual A – B, Dual A – AUX, Dual B – AUX AUX Mode: AUX-Bus, MAS. A Pre, MAS. A Post Limiters: <ul style="list-style-type: none"> MASTER A: -10 – +11 dBu MASTER B: -10 – +11 dBu AUX Limiter: -10 – +11 dBu 	<p>In this menu you can configure advanced features of the PM 502 outputs. Please refer to the corresponding sections for more details:</p> <ul style="list-style-type: none"> 100 V Direct Drive, page 16 Amplifier routing, page 16 AUX mode, page 17 <p>The audio limiter thresholds can be set independently for the MASTER A, MASTER B or AUX output signals.</p>
DEVICE SETUP 1	<ul style="list-style-type: none"> LCD Auto Dim: Off–60 Min. Dim Brightness: 0–100% 	After the time set here the display brightness is dimmed. The brightness of the display in dimmed mode can be adapted to the installation location.
	<ul style="list-style-type: none"> Screensaver: Off–60 Min. (default: Off) Personalize 	After the time set here the screensaver is activated. You can personalize the device name shown in the screensaver screen.
DEVICE SETUP 2	<ul style="list-style-type: none"> Lock/Unlock: 0000–9999 Lock Mode: Custom, Level 1,2,3 	Enter a 4 digit PIN (password) to lock certain parameters of the PM 502. Please refer to section <i>Locking</i> , page 18 for more details.
	<ul style="list-style-type: none"> Factory Reset 	Pressing the MENU/ENTER rotary encoder opens a “Reset all settings?” safety dialog box. Select YES to reset the PM 502 to its factory settings. Select NO to return to the DEVICE SETUP menu. If the device is locked a factory reset is not possible.
INFORMATION	<ul style="list-style-type: none"> Firmware Mains: Voltage and frequency Int. Temp: Current and maximum value Logging 	Indicates the firmware version installed, the current supply voltage and frequency and the internal temperature of the device. The entry Logging is for service only.

Table 7.2: Menu

7.9 Indicators

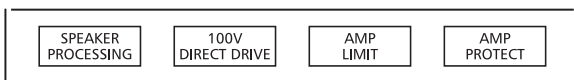

This section describes the indicators at the front panel of the PM 502.

Indicator	Description
SPEAKER PROCESSING	This indicator lights up blue when the internal speaker processing of the PM 502 is activated in the menu. Please refer to section <i>Speaker processing (LPN)</i> , page 17 for more details about this mode.
100V DIRECT DRIVE	This indicator lights up green when the 100 V Direct Drive mode is activated in the menu. Please refer to section <i>100 V Direct Drive</i> , page 16 for more details about this mode.
AMP LIMIT	This yellow indicator signals that you are operating the PM 502 at the internal power amp's limit. Frequent blinking of the LED is acceptable, since the amplifier's incorporated clip limiter prevents distortion. Continuous lighting indicates that you have to be aware of degradation in the output sound. In that case, the MASTER (or AUX) level has to be reduced. The LIMIT LED also lights up if the output level is reduced because of high amplifier temperature or too high output current in abnormal load conditions.
AMP PROTECT	This indicator lights up red when one of the PM 502's extensive protection circuits – against thermal overload, HF-induction, Back-EMF, DC at the outputs, and short circuit protection – is activated. When the PM 502 is in protect mode, the speaker outputs are disabled to prevent the power amp from being damaged. In this case you should first check whether the ventilation slots are blocked. Another cause could be that you have connected more than two 8 Ω speaker systems per power output in low-Z mode. Please also disconnect the speakON or Euroblock connectors and check the speaker cables for short circuits.

Table 7.3: Front panel indicators

7.10 Headphone volume

This control sets the volume of the connected headphones (see section *Headphone*, page 15).

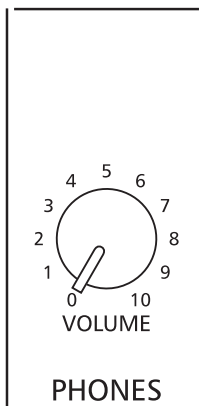

Caution!

Make sure to set the PHONES VOLUME control to its minimum position before connecting headphones. Permanent hearing loss may occur if headphones are used at high volume.

8 Maintenance

The PM 502 does not require any maintenance.

9 Technical data

Channels (mono + stereo)	5 + 3
Microphone inputs	5 x XLR/Jack socket
Auxiliaries (FX, AUX)	1 Post, 1 Pre
Max. single channel output power, dynamic headroom, IHF-A	
• into 4 Ω	640 W
• into 8 Ω	350 W
Max. dual channel output power, dynamic headroom, IHF-A	
• into 4 Ω	2 x 600 W
• into 8 Ω	2 x 340 W
Max. single channel output power, continuous, 1 kHz, THD = 1%	
• into 4 Ω	500 W
• into 8 Ω	280 W
Max. midband output power, 1 kHz, THD = 1%, dual channel	
• into 4 Ω	2 x 450 W
• into 8 Ω	2 x 270 W
Rated output power, 20-20000 Hz, THD < 0.5%, one channel loaded	
• into 4 Ω	400 W
• into 8 Ω	240 W
Max. output power, Direct Drive mode (bridge configuration), continuous, 1 kHz, THD = 1%	
• into 12 Ω	680 W
Max. output voltage, power amplifier, 1 kHz, no load	
• Dual channel mode	52 V _{rms}
• Direct Drive mode	100 V _{rms}
THD, at 1 kHz, MBW = 22 kHz	
• MIC input to master A L/R outputs, +10 dBu, typical	< 0.015%
• MIC input to speaker output	< 0.15%
DIM 30, MIC input to speaker output, 3.15 kHz, 15 kHz	< 0.05%
IMD-SMPTE, MIC input to speaker outputs, 60 Hz, 7 kHz	< 0.15%
Frequency response, -3 dB, ref. 1 kHz	
• Any input to any Mixer output	15–22000 Hz

• Any input to Speaker output	20–22000 Hz
Crosstalk, 1 kHz	
• Amplifier Ch1/Ch2	< -85 dB
• Channel to channel	< -78 dB
Microphone mute switch attenuation	> 100 dB
Channel VOL and FX/AUX send attenuation	> 85 dB
CMRR, MIC input, 1 kHz	> 80 dB
Input sensitivity, all level controls in max. position	
• MIC	-65 dBu (435 μ V)
• LINE (mono)	-45 dBu (4.35 mV)
• LINE (stereo)	HI: -27 dBu (34.6 mV), LO: -11 dBu (218 mV)
• CD (stereo)	-27 dBu (34.6 mV)
Max. level, mixing desk, input VOL down, output VOL up	
• MIC inputs, GAIN at min. position	+11 dBu
• Mono line inputs, GAIN at min. position	+30 dBu
• Stereo line inputs	+26 dBu
• PHONES output	+21 dBu
• MASTER A, B, AUX outputs	+11 dBu
Input impedances	
• MIC	2 k Ω
• CD	10 k Ω
• All other inputs	> 15 k Ω
Output impedances	
• PHONES	47 Ω
• All other outputs (impedance balanced)	150 Ω
Equivalent input noise, MIC preamp, A-weighted, max. gain, 150 Ω	-129 dBu
Noise, channel inputs to MASTER A L/R outputs, MBW = 22 kHz, A-weighted	
• MASTER VOLUME down	-99 dBu
• MASTER VOLUME center, all channel volume down	-90 dBu
• MASTER VOLUME center, all channel volume center	-85 dBu
Signal-to-noise ratio, power amplifier, A-weighted, 450 W, 4 Ω	104 dB

Output stage topology, amplifier	Class D
Equalization	
• Low shelving filter	±15 dB / 60 Hz
• Mid peak filter	±12 dB / 2.4 kHz
• High shelving filter	±15 dB / 12 kHz
Master EQ 7-band (63, 160, 400, 1k, 2.5k, 6k, 12k Hz)	±10 dB / Q = 1.5
Filter	
• Low-cut filter, microphone processing (switchable)	80 Hz, 18 dB/oct. or 150 Hz, 12 dB/oct.
• Low-cut filter, amplifier (engaged in Direct Drive mode)	50 Hz or 70 Hz, 18 dB/oct.
• Speaker processing	LPN, switchable
Delay MASTER B, selectable	0–145 ms (0–50 m)
Effects	
• Type	Stereo 24/48-bit multi effects processor
• Effect presets	32 factory presets, user editable
• Remote control	Footswitch
Display	128 x 64 pixels, LCD
Audio player (USB at front panel)	
• Switching mode power supply (µC controlled)	FAT 32
• Supported audio file formats	MP3, WAV
• Interface	USB2.0, female type A
• USB power supply, max. rated current (short circuit proof)	5 V, 500 mA
Digital audio interface (USB at rear panel)	
• Channels	2 in, 2 out
• AD/DA conversion	16-bit, delta-sigma
• Sampling rate	32/44.1/48 kHz
• PC interface	USB2.0, female type B
Protection	
• MASTER A, B, AUX outputs	Adjustable peak limiters, -10 – +11 dBu
• Amplifier	Audio limiters, high temperature, DC, HF, short circuit, peak current limiters, turn-on delay, back EMF

• Switching mode power supply (μ C controlled)	Inrush current limiters, mains over/undervoltage, mains over current, high temperature
Cooling	Continuous speed controlled fan
Phantom power, switchable	48 V DC
AC power input	100–240 V AC, 50–60 Hz
Power consumption, at 1/8 maximum output power, 4 Ω	180 W
Safety class	I
Operating temperature	5° to 40° C (40° to 105° F)
Product dimensions (Width x Height x Depth)	395 x 244 x 241 mm Rack-mount: 483 x 223 x 310.3 mm (7 HU)
Net weight	4.9 kg
Shipping weight	6.4 kg

Table 9.1: Device in rated condition: MIC GAIN 15 dB, STEREO GAIN LO, all channel and master controls in center position, 100 V Direct Drive mode: Off, LPN HIGH, amplifier load 8 ohms, dual channel, mains voltage 230 V/50 Hz or 120 V/60 Hz, unless otherwise specified.

NEUTRIK, speakON and etherCON are registered trademarks of Neutrik AG.

9.1 Dimensions

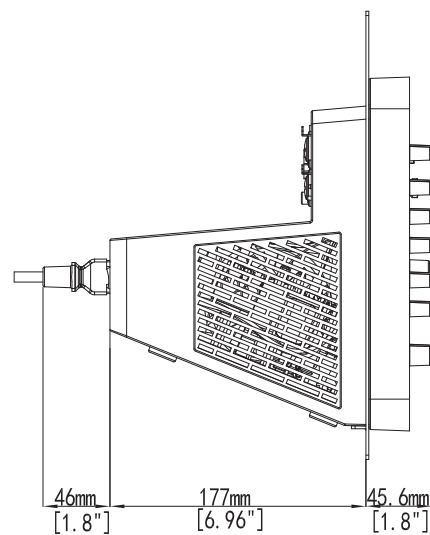
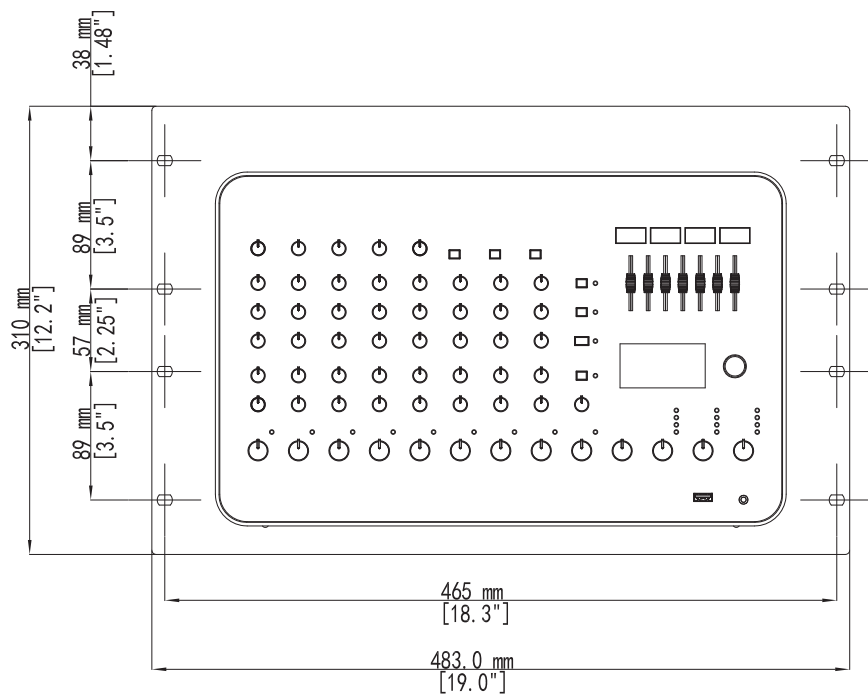
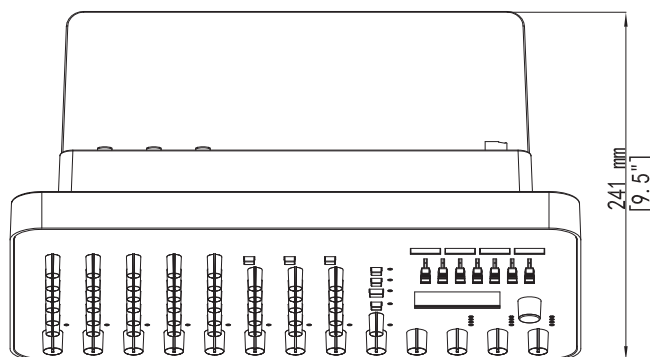
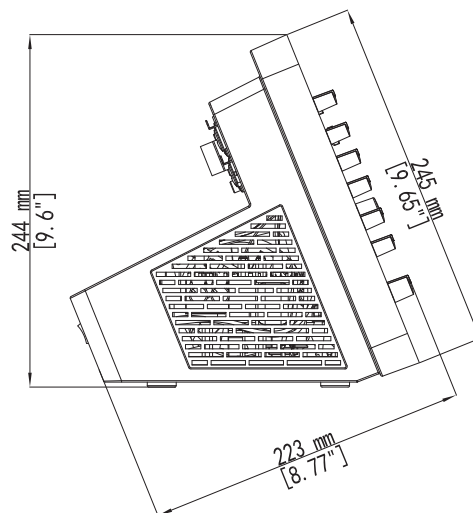
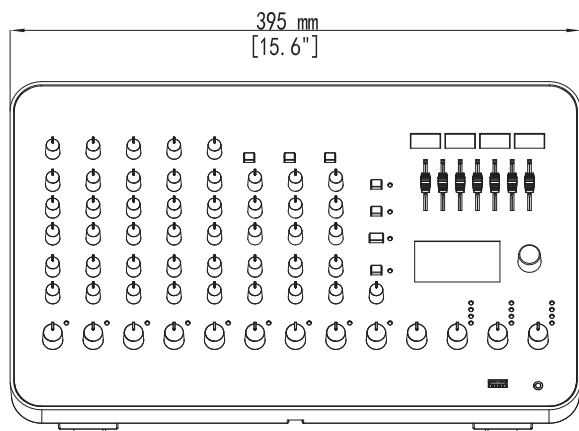

9.2 Circuit diagram

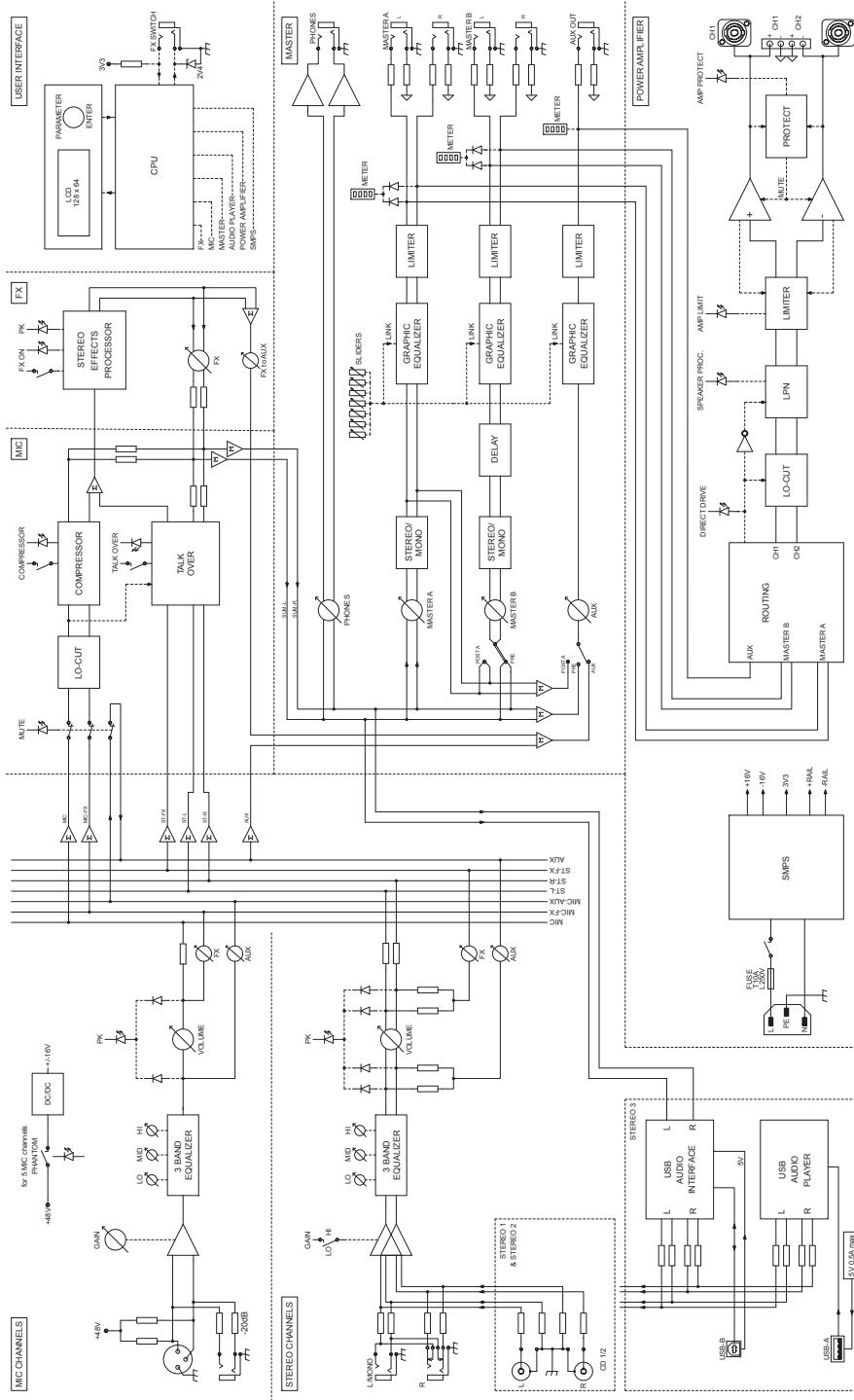

10 Appendices

10.1 System examples

Bistro or club

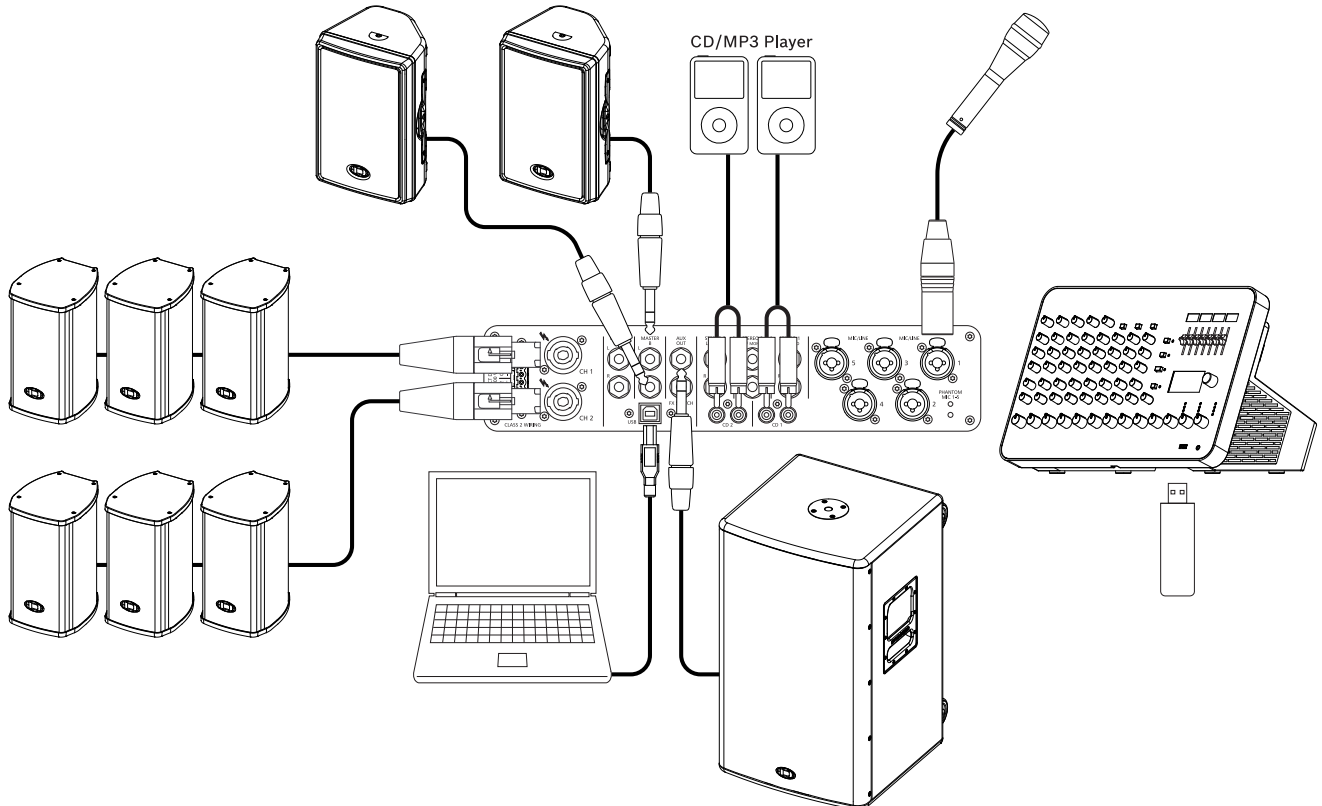

In this application the integrated amplifier of the PM 502 drives three TS 100 speakers per output channel (low-Z mode). Powered speakers and subwoofers are connected to MASTER B or AUX OUT. Signal sources are connected via mic/line level inputs and USB. Additionally an USB stick is connected for using the internal audio player.

Live music

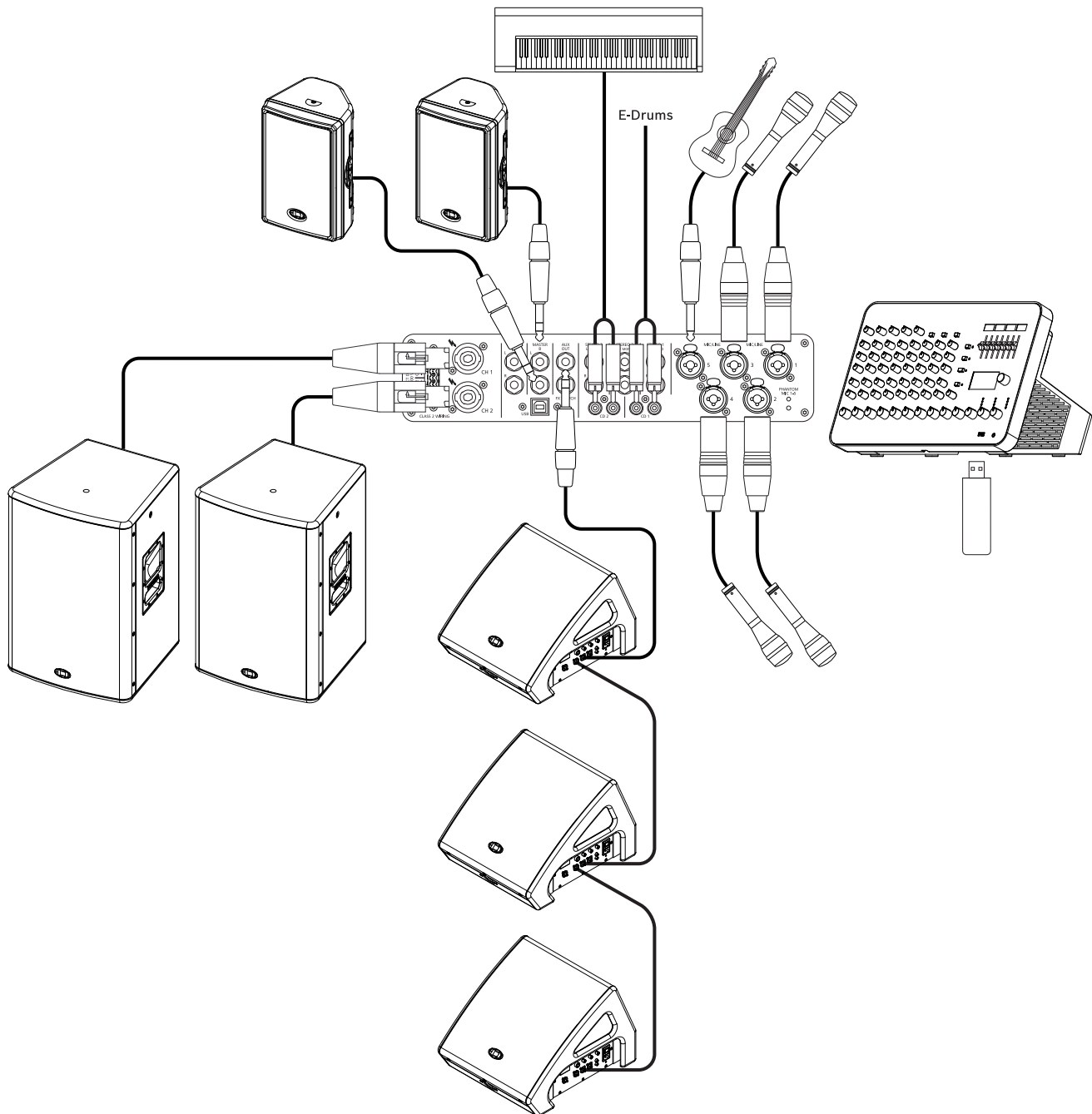

In this application the integrated amplifier of the PM 502 drives one C 15.2 speakers per output channel (low-Z mode). Powered speakers (e.g. D 8A) as side room PA are connected to MASTER B. Powered monitor speakers (e.g. AXM 12A) are connected to AUX OUT. Signal sources are connected via mic/line level inputs. Additionally an USB stick is connected for using the internal audio player.

Church or mosque

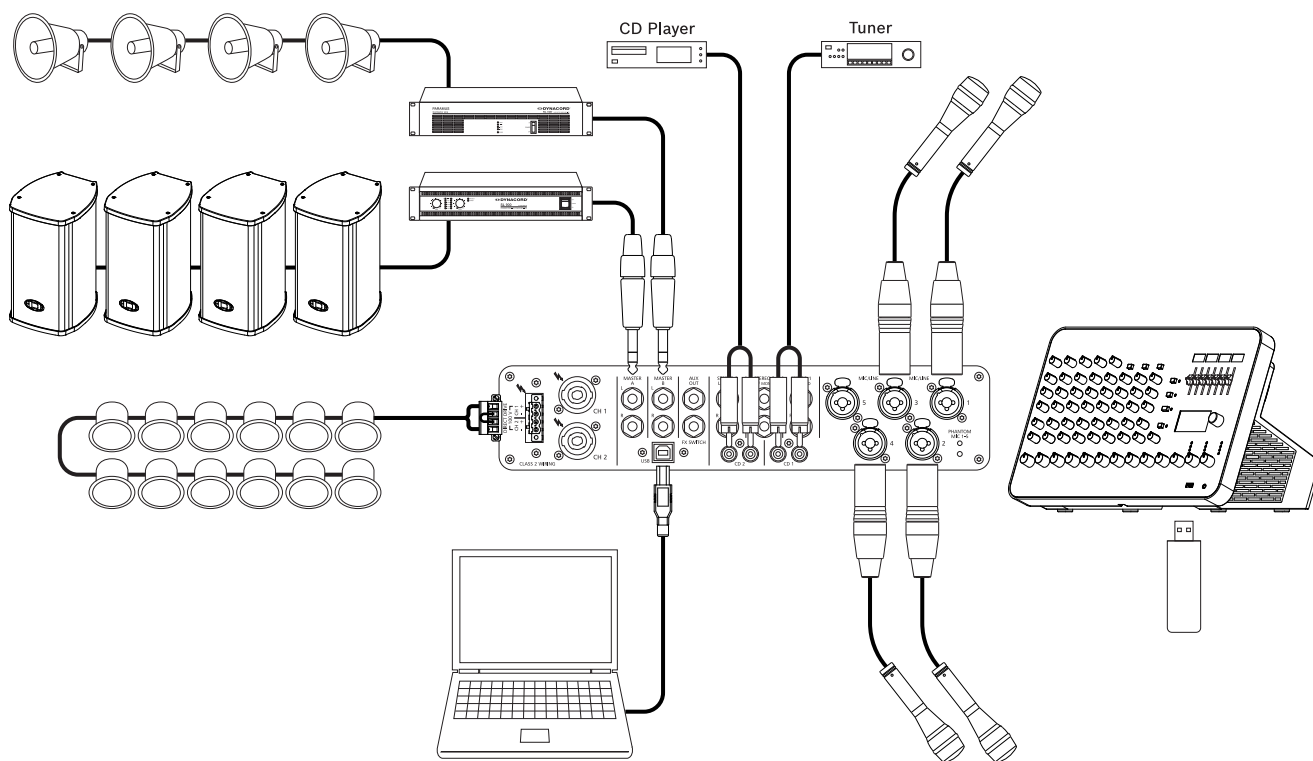

In this application the integrated amplifier of the PM 502 drives a 100 V speaker line with ceiling speakers (Direct Drive, high-Z mode). A SL power amplifier driving four TS 100 speakers is connected to MASTER A output (set to Mono). A PCL power amplifier driving four DL 800 horns is connected to MASTER B (set to Mono). Signal sources are connected via mic/line level inputs and USB. Additionally an USB stick is connected for using the internal audio player.

Mall or large shop

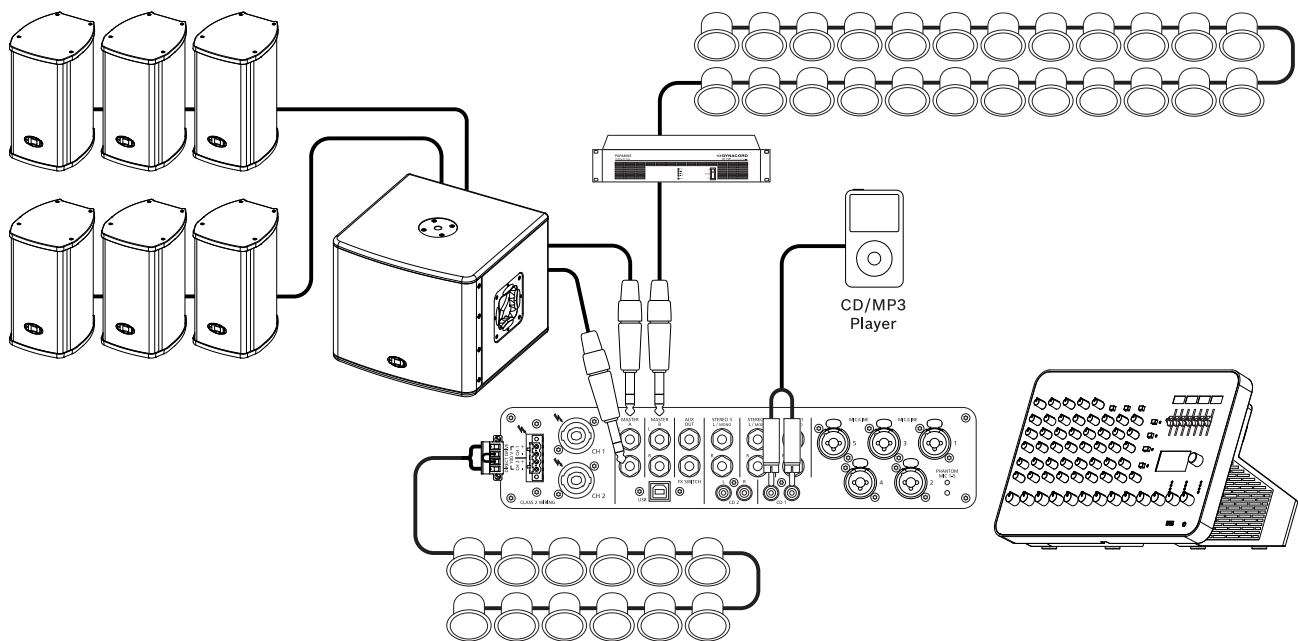

In this application the integrated amplifier of the PM 502 drives a 100 V speaker line (zone 1) with ceiling speakers (Direct Drive , high-Z mode). A PowerSub 312 driving six TS 100 speakers is connected to MASTER A output. A PCL power amplifier driving another 100 V speaker line (zone 2) with ceiling speakers is connected to MASTER B (set to Mono). As signal sources a CD/MP3 player is connected via line level input STEREO 1.

10.2 Pin assignments

UNBALANCED

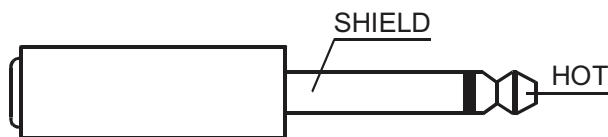

Figure 10.1: Unbalanced assignment of mono jack

BALANCED

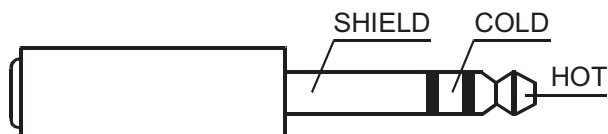

Figure 10.2: Balanced assignment of stereo jack

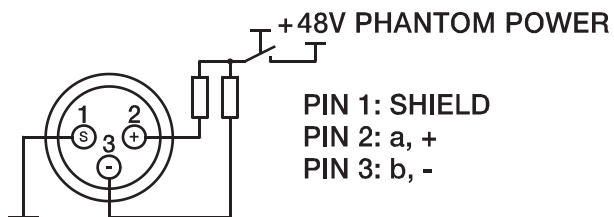

Figure 10.3: Pin assignment of XLR microphone input with phantom power

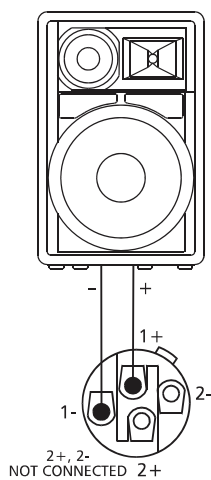

Figure 10.4: Pin assignment of speaker output CH 1/2 (low-Z, speakON)



Bosch Sicherheitssysteme GmbH

Robert-Bosch-Ring 5

85630 Grasbrunn

Germany

www.dynacord.com

© Bosch Sicherheitssysteme GmbH, 2014

